



# PC-Profile





PC installation profiles are made of Lotte LOTTE PC-1070U polycarbonate raw materials, and PC-1070U has excellent anti-aging properties. The construction process is convenient and the joint treatment is simple. It is suitable for the simple installation of sunshine board engineering.

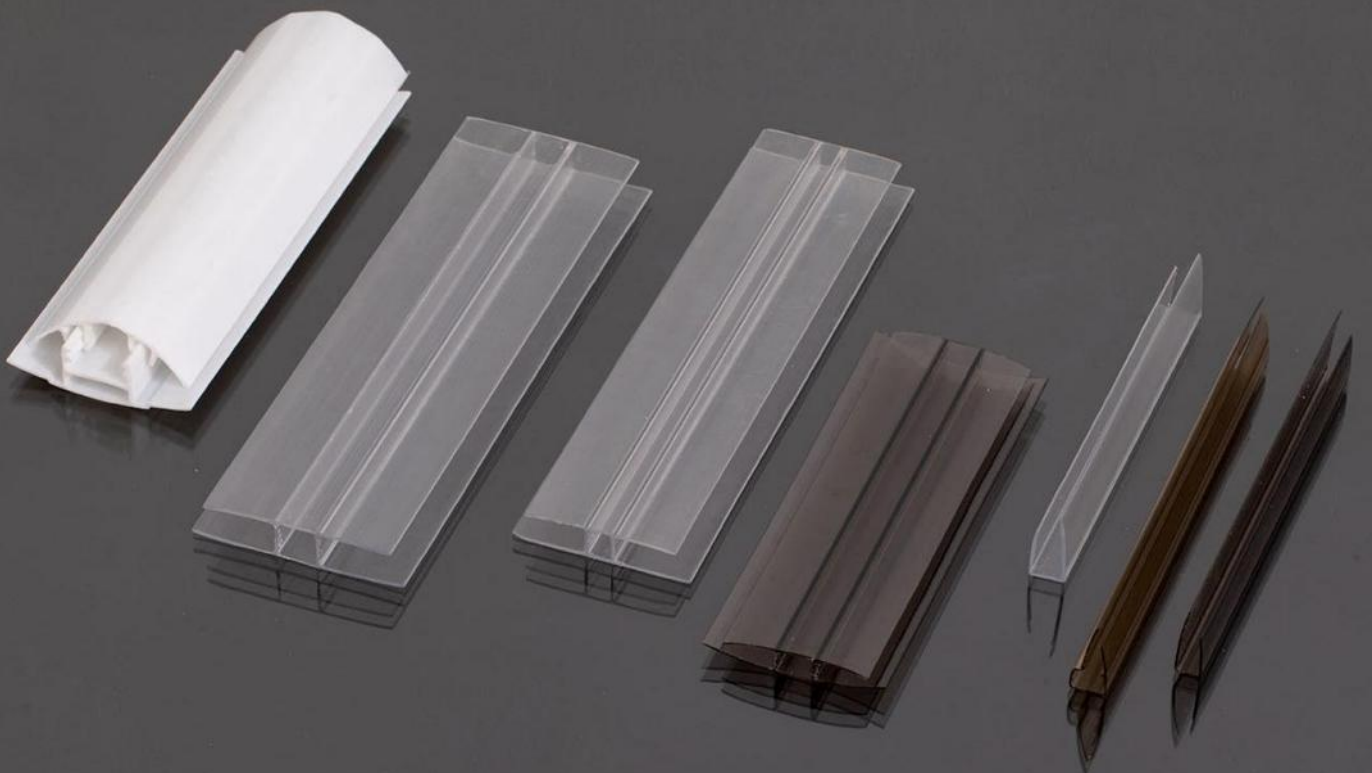

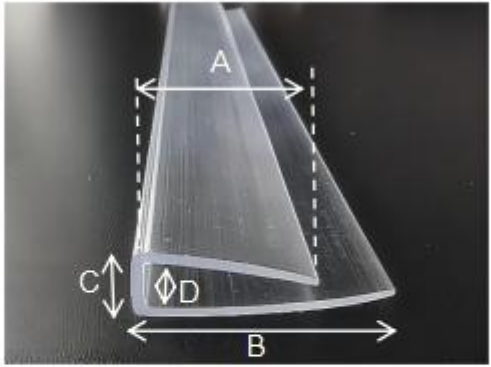
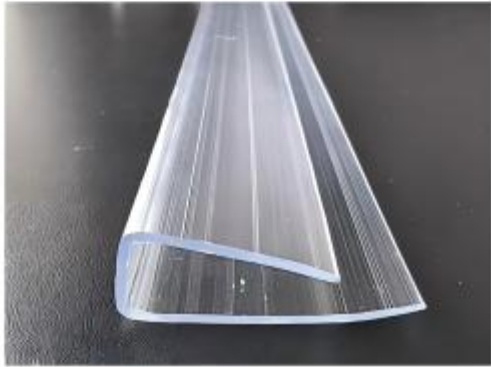
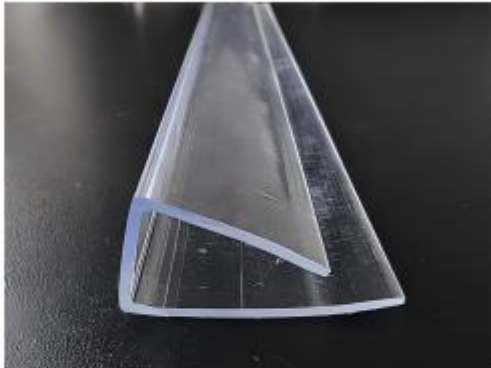
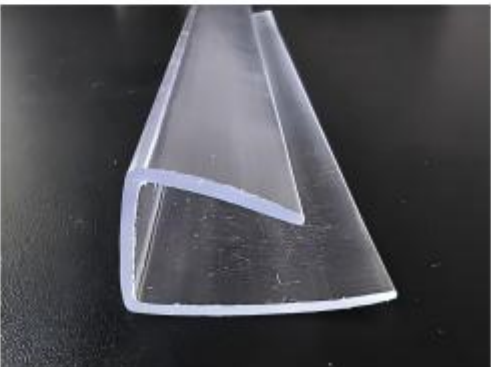
No.	Picture	A ±3mm	B ±3mm	C ±1mm	D ±1mm	Apply to (mm)
4U		15.5	22	6.3	4.2	4
6U		16.7	24	8.3	6.4	6
8U		17.3	23.9	11.2	8.6	8
10U		13.6	22.7	13	10.5	10

No.	Picture	A ±3mm	B ±3mm	C ±1mm	D ±1mm	Apply to (mm)
10U-A		20.3	20.3	12.9	11	10
6U-A		18.8	25.6	11	4.8	6
7U		29.4	33.5	10.7	7.7	7

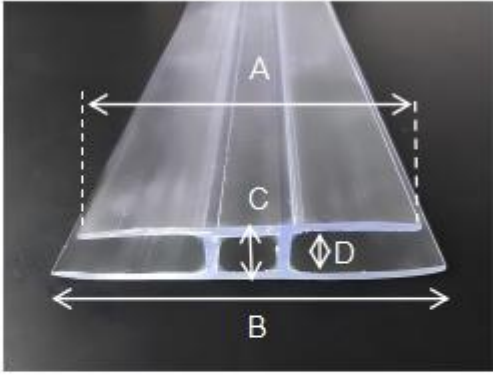
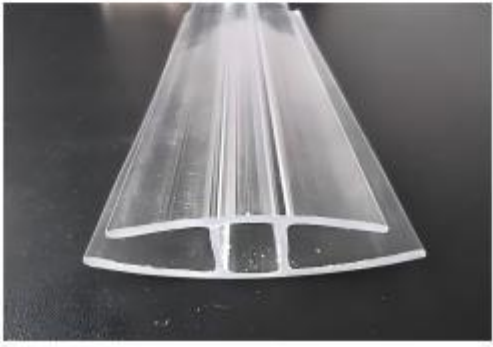
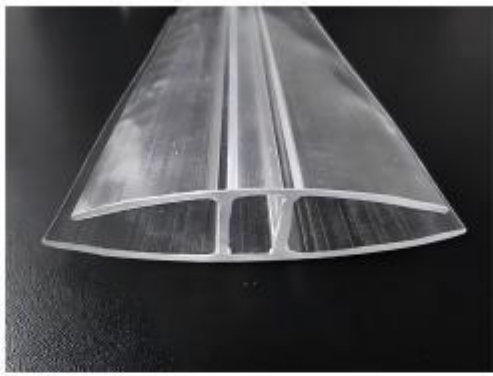

No.	Picture	A ±3mm	B ±3mm	C ±1mm	D ±1mm	Apply to(mm)
4H		36.5	45.3	7.7	5.8	4
6H		35.3	44.7	9.7	6.9	6
8H		47.5	56	11.5	9	8
10H		58.8	67	13.7	10.8	10

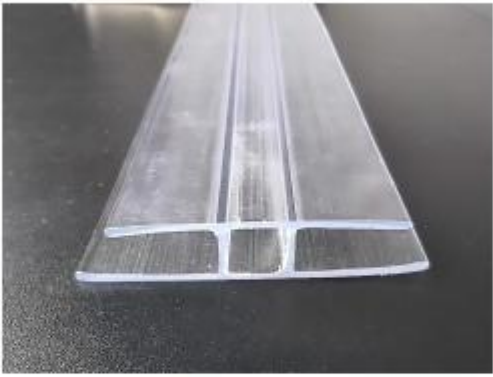
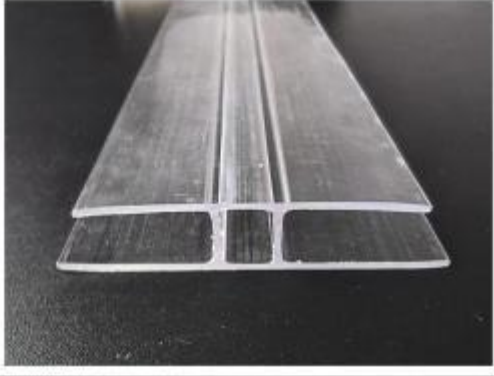
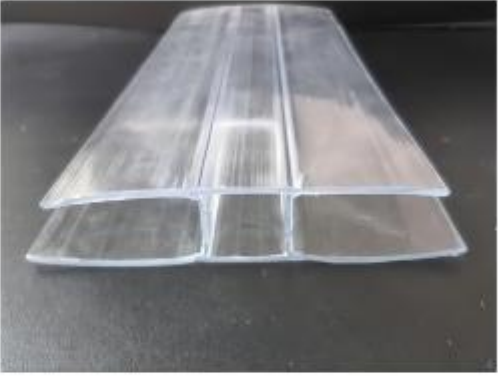
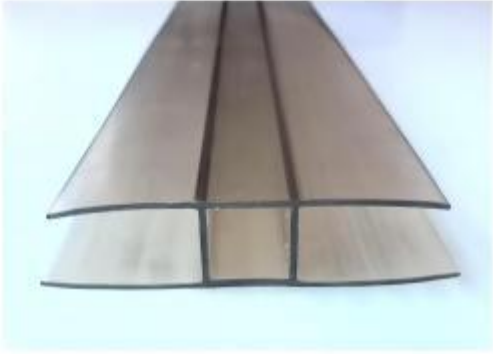
No.	Picture	A ±3mm	B ±3mm	C ±1mm	D ±1mm	Apply to (mm)
6H-B		36.3	45	9.5	7.2	6
8H-B		47	56	11.3	9.1	8
10H-B		58.7	67.2	13.5	10.8	10
12H-B		55	62	14.3	12.5	12

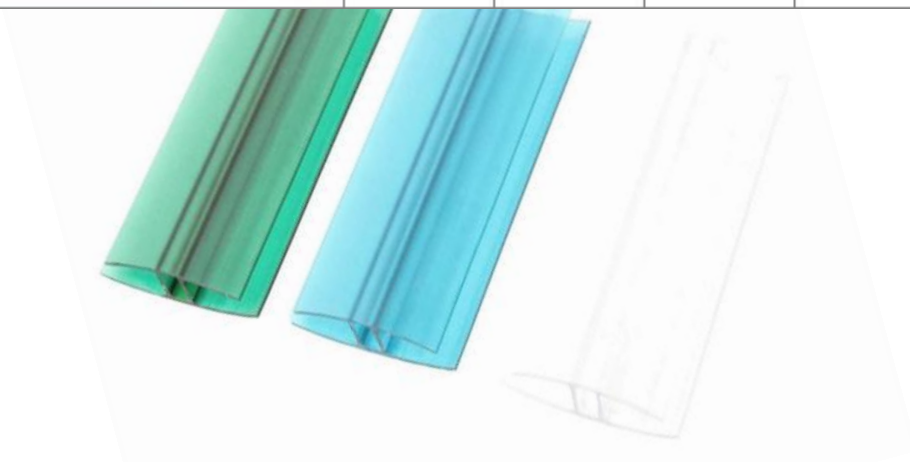

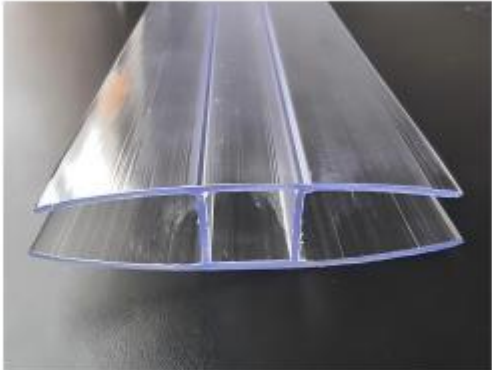
No.	Picture	A ±3mm	B ±3mm	C ±1mm	D ±1mm	Apply to (mm)
12H		56.2	61.3	14.5	12.3	12
4H-W		46.6	56.3	7.7	5.5	4
6H-W		51.2	61.2	9.6	6.8	6
7H		48.5	57.2	10.6	7.8	7

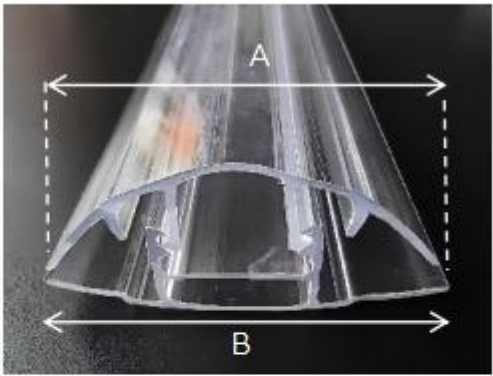
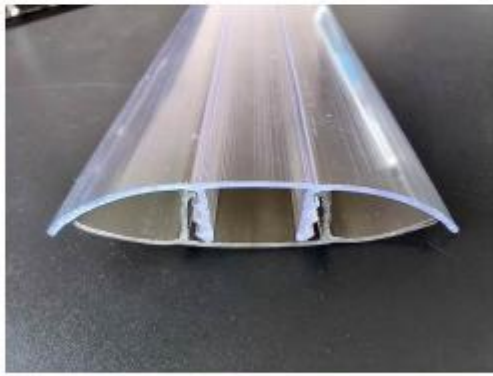
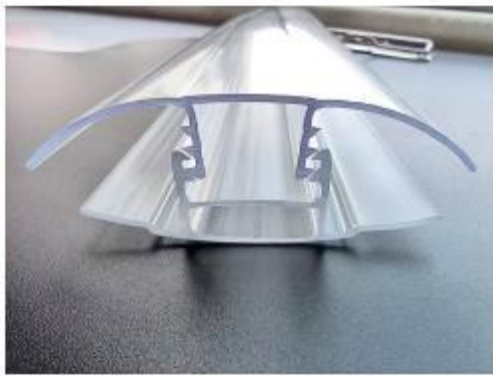
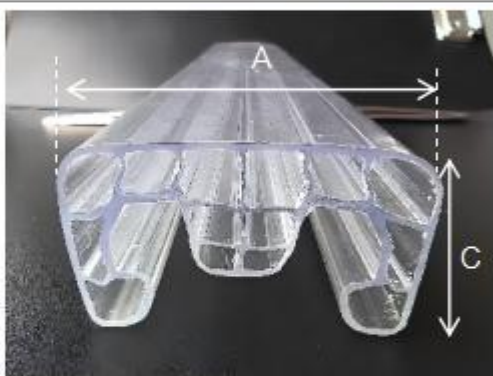
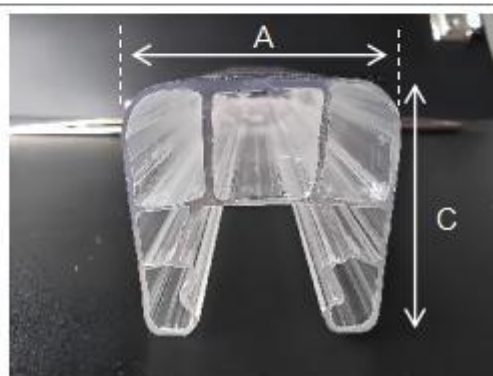
No.	Picture	A ±3mm	B ±3mm	C ±1mm	D ±1mm	Apply to mm
AB4-10		58	60	/	/	4^10
AB4-16		65	58	/	/	4^16
AB8-16		65	60	/	/	8^16
N-1		38.8	/	23	/	U- shaped lock exclusive
N-2		28.3	/	28.5	/	U- shaped lock exclusive

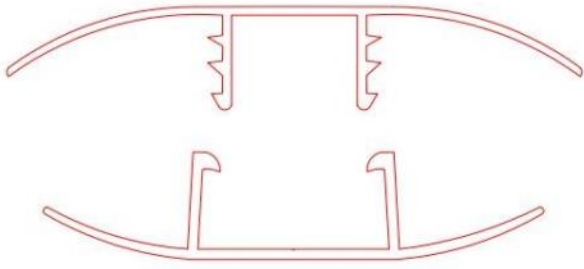

Drawing design

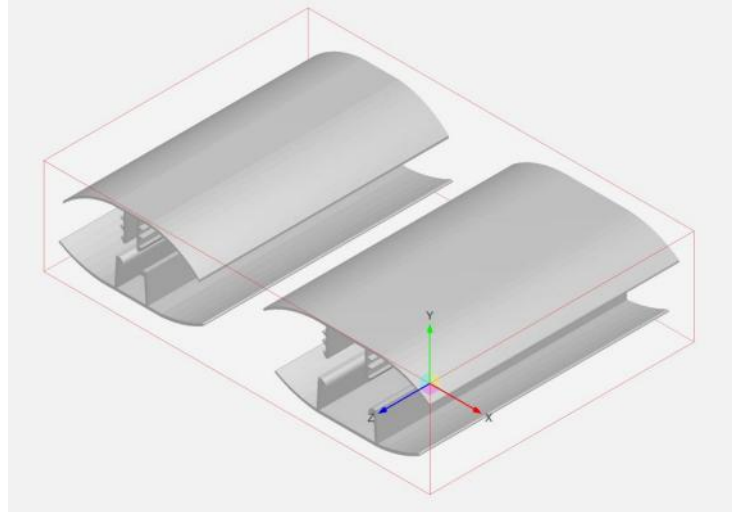

Modeling

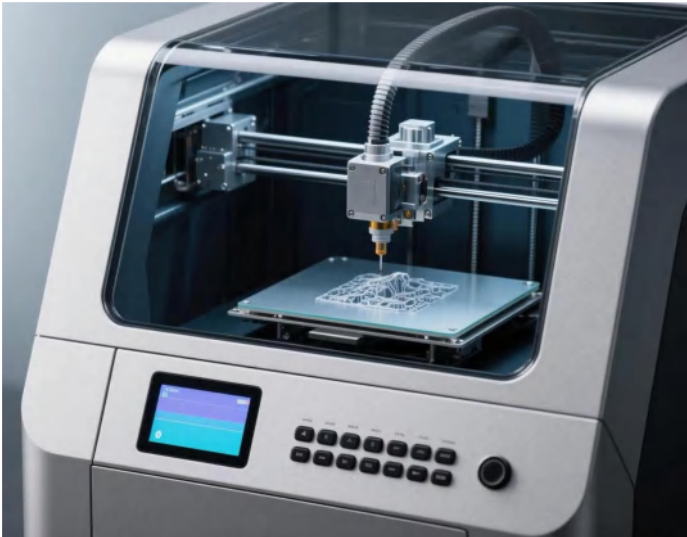

3D Printing

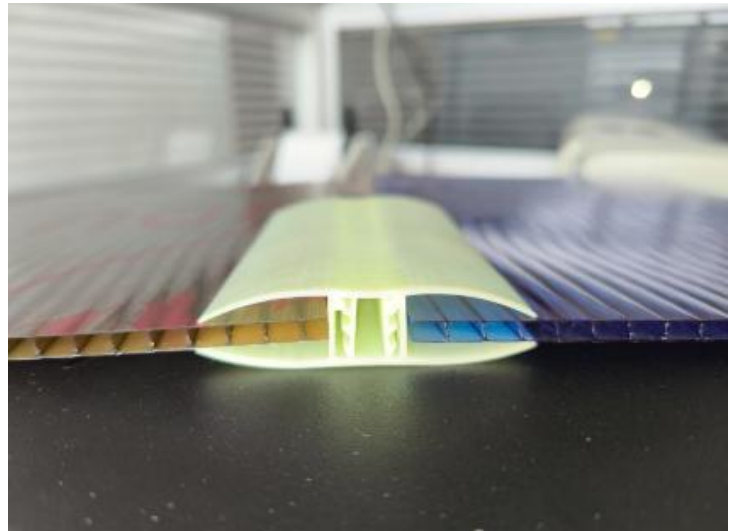

3D printing sample testing

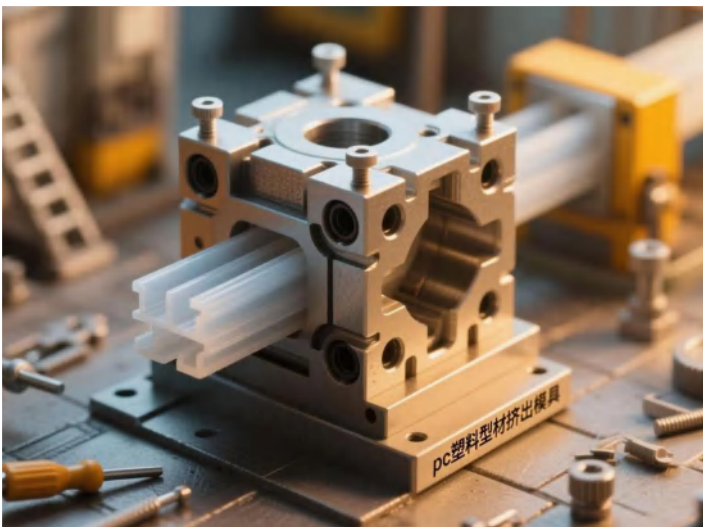

Mold Development



Produce



U-Profile

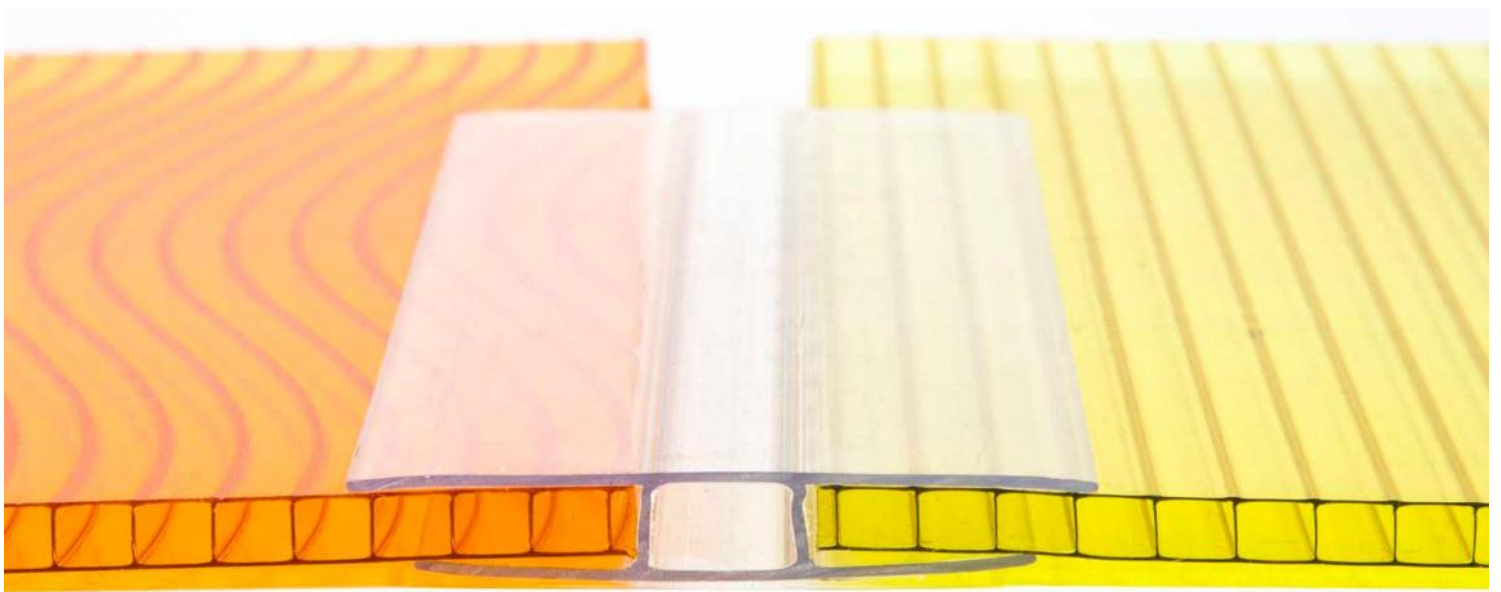

H-Profile

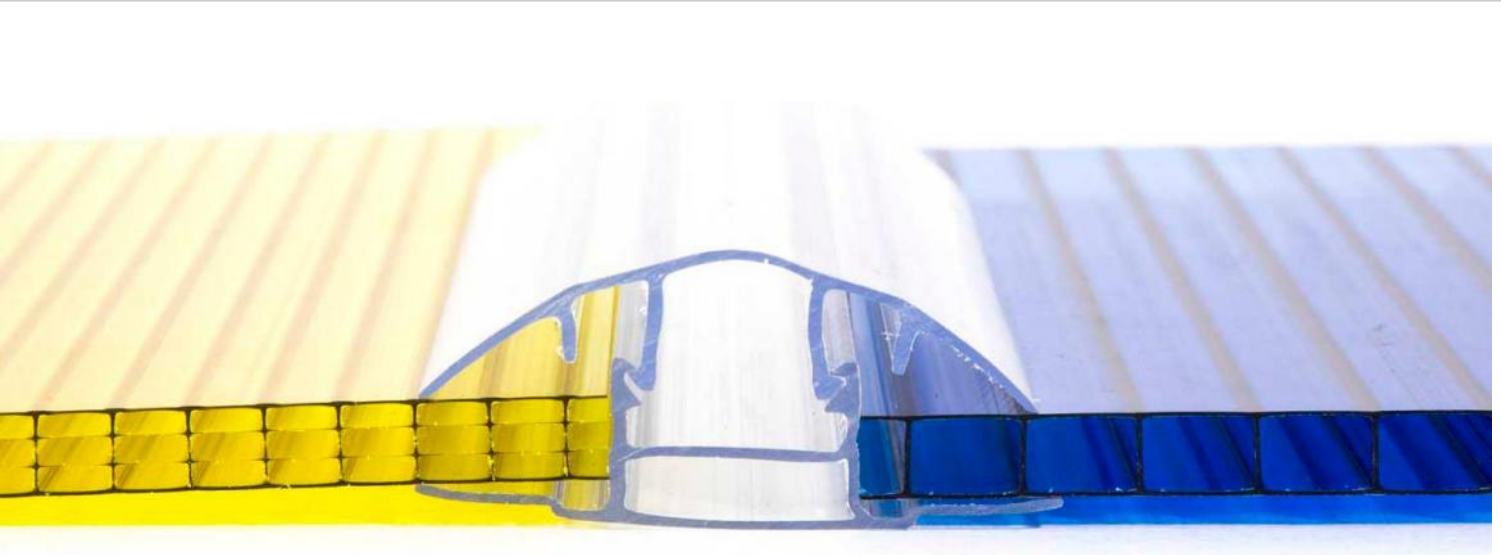

Up and down profile

# TIPS

- 1、 **Storage requirements:** store in a cool and dry place. No exposure to the sun or rain.
- 2、 **Sealant:** neutral silicone sealant shall be used, and glass sealant with acid-base properties is strictly prohibited. The resulting problems will not be guaranteed.
- 3、 **Operating environment:** PC accessories are not acid-base resistant. They can not be directly contacted with the cement wall, and can not be used in acid-base substances and gas environment.

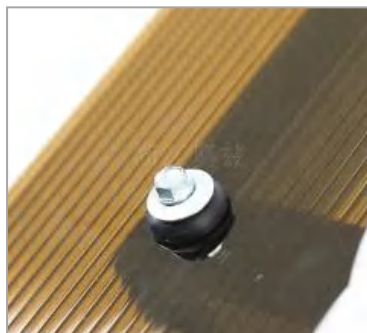
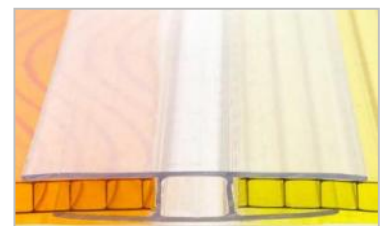
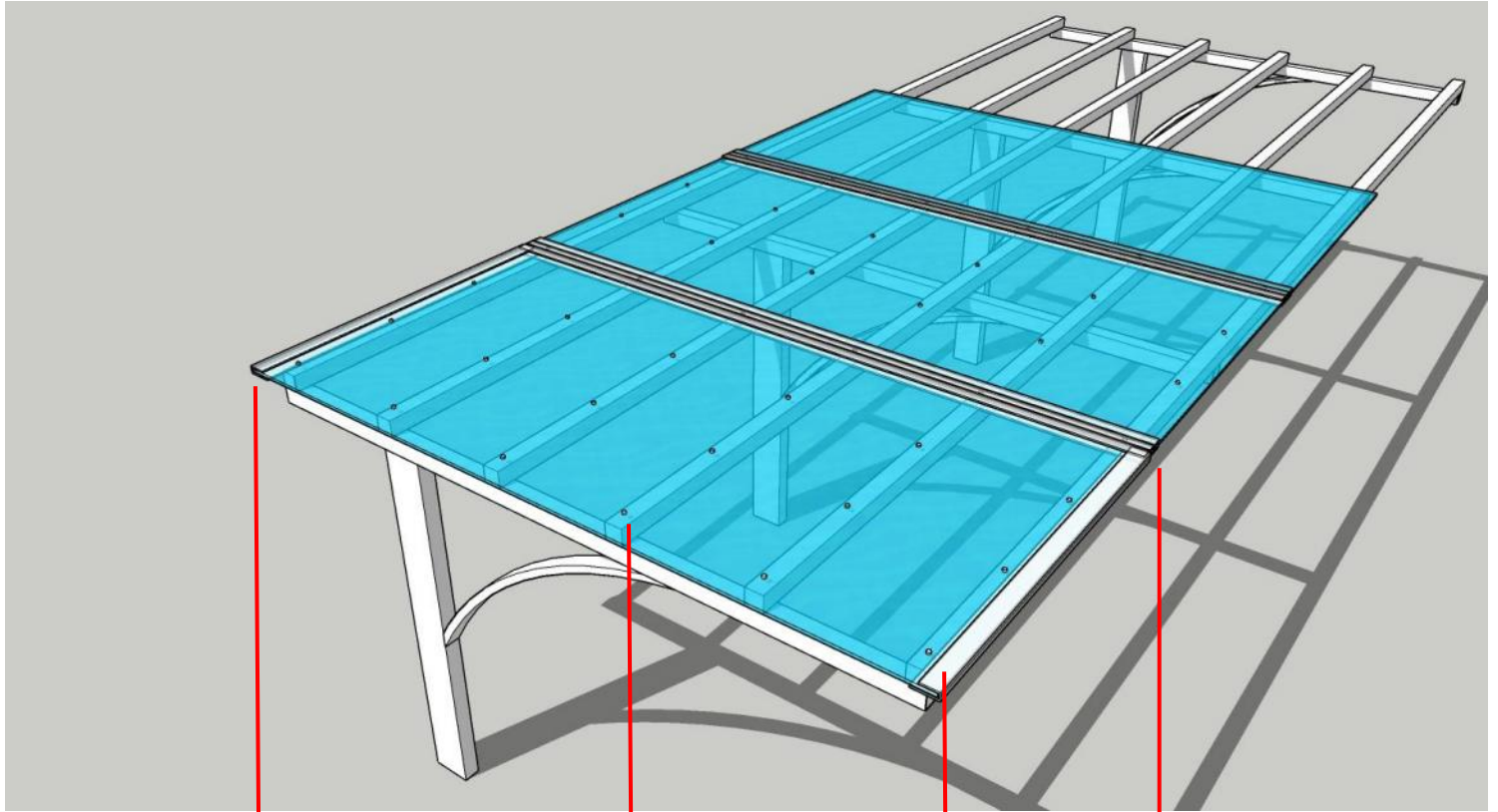

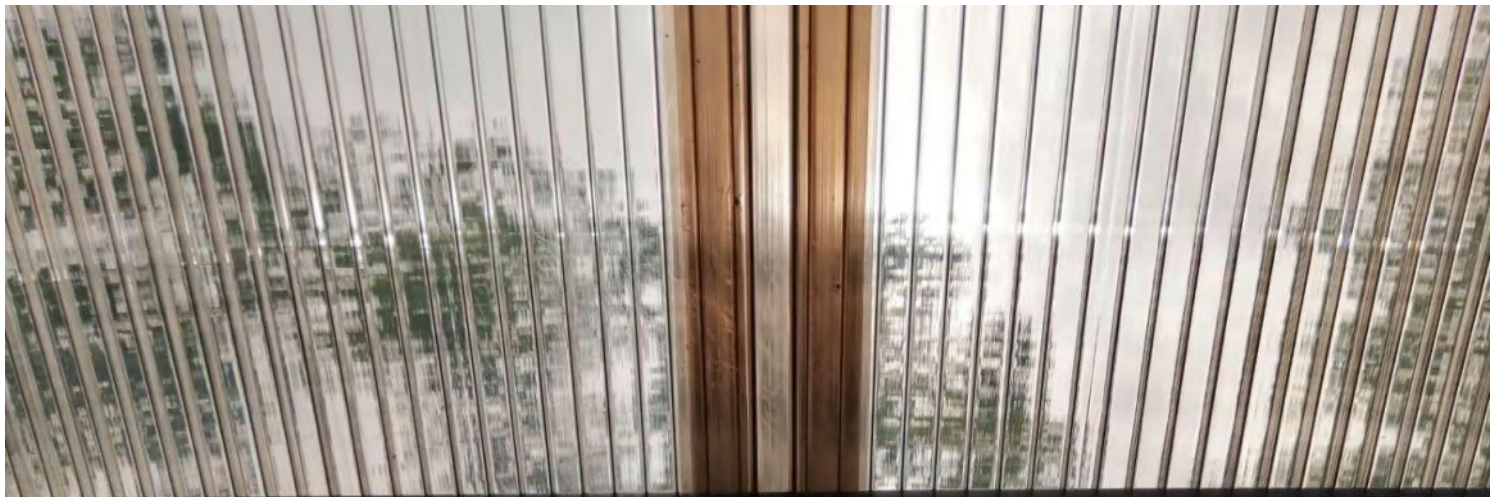



Covestro raw material



raw material



Covestro raw material

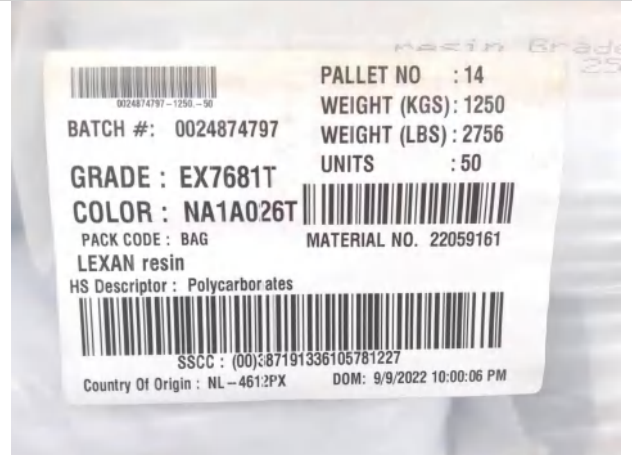

SABIC UV raw material



transport



transport



factory



factory

